



Shahrood University of
Technology



Using neural networks to predict road roughness

A. Soleimani^{1,*} and A. Sahebi²

¹ Associate Prof., Dept. of Electrical Engineering, Shahrood University of Technology, Shahrood, Iran

² MSc. Student of Electrical Engineering, Shahrood University of Technology, Shahrood, Iran

Abstract

When a vehicle travels on a road, different parts of vehicle vibrate because of road roughness. This paper proposes a method to predict road roughness based on vertical acceleration using neural networks. To this end, first, the suspension system and road roughness are expressed mathematically. Then, the suspension system model will identify using neural networks. The results of this step show that the neural networks model of suspension system will be well. The mean and max errors are 0.0013% and 0.0012, respectively. Finally, the inverse suspension system model is extracted by using neural networks to determine the relationship between road roughness and vibration or displacement. Using this step to predict the road quality. In this step, the mean error is 2.1% and max error is 0.028. Therefore, the results show that the proposed method can be used to identify the suspension system, inverse suspension system and predict the quality of roads.

Keywords: Road roughness prediction; Neural networks; Suspension system; Modeling.

1. Introduction

Nowadays, passenger and cargo transport are the most important financial issues for every country. The quality of transport depends on factors such as road quality [1]. While a vehicle travels on the road, the different parts of vehicle vibrate. Factors such as tier dynamic, suspension system, road roughness and vehicle body structure affect the scale of vibration. Vehicle vibration is mainly due to road roughness [2,3]. The roughness of a road surface is an important measure of road condition and a key factor in determining vehicle operating costs on poor quality surfaces [1]. Acceleration measurement has some applications in control suspension system [2, 4, 5], airbag opening in vehicles in case of accident, detecting errors in mechanical systems [6, 7], evaluating convenience of vehicle [8, 9] and evaluating quality of the road [1, 10, 11, 12]. Road noises in vehicles appear in vertical and horizontal acceleration. The effect of road roughness on the design and operation of road vehicles has been a subject of intensive research since 1960. In order to determine road quality, vehicle vibrations due road roughness is acquired by accelerometer. The quality of road is determined by the chain processes of

vibration [1, 11]. A number of instruments have, therefore, been developed for measuring roughness, but many of them are expensive, slow in use or require regular calibration [1]. They can be categorized either as response-type instruments or profiling devices [10]. In order to evaluate the road quality, this paper presents a new method based on response-type instruments. The main advantage of the proposed method is low cost and showing the road profile. This research studies and combines the suspension system model, road roughness, neural networks and inverse suspension system model.

Suspension system modeling [2, 3, 4, 13, 14] is used in designing active suspension system, evaluating convenience of vehicle [8, 9] and evaluating quality of the road.

The impressive advantages of neural networks are the capability of solving highly non-linear and complex problems and the efficiency of processing imprecise and noisy data [13]. Neural networks have been widely used to estimate the nonlinear model of system and control of system [3, 13, 15, 16, 17]. Also, neural networks have been used to estimate the nonlinear inverse model of system in order to control and observe data [13, 17, 18, 19]. Mathematically,

* Corresponding author, Phone: +989123740965
Email: solimani_ali@shahroodut.ac.ir

the inverse problems are classified as ill-posed problems. A problem is considered well-posed if there exists a solution and it is unique and stable related to the input data. In general, these conditions are not satisfied for the inverse problems, because of small variations in the input data, such as error of measurement, can cause large oscillations on the solution. They might not have a strict solution. The solution should not be unique and/or should not depend continuously on the data. Hence, their mathematical analysis is subtle. However, they have many applications in engineering, physics and other fields. Usually the inverse problem, that is assumed to be the ill-posed problem, is presented as a well-posed functional form, the solution of which is obtained through the use of optimization procedures [19].

The organization of this paper is as follows: in section 2 a short review of accelerometer is presented; in section 3 the model of suspension system and road roughness is introduced; in section 4, the model of the suspension system and the inverse suspension system model with neural networks is introduced; and finally, the concluding remarks are described in section 5.

2. Accelerometer

An accelerometer is a device that can measure acceleration in single-axial or multiple-axial [11]. The output of an accelerometer is a small signal amplified with an amplifier. A modern accelerometer as shown in Fig. 1 contains a *Micro Electro Mechanical Systems* (MEMS) sensor, a regulator, an analog to digital converter, a processor and a TTL to RS485 converter. The proposed accelerometer which is built over a strong magnet is shown in Fig. 2. It is movable and can easily be installed on the suspension system. Sensor size is about 67×35×20 mm and its sampling rate is 500 samples per second and can transfer information with 980 Kbit/s. An accelerometer which measures wheel acceleration is mounted on wheel axes. A sample measured with this device is shown in Fig. 3. This figure shows x,y,z acceleration versus speed of vehicle. This figure shows that there is a relationship between road roughness and acceleration.

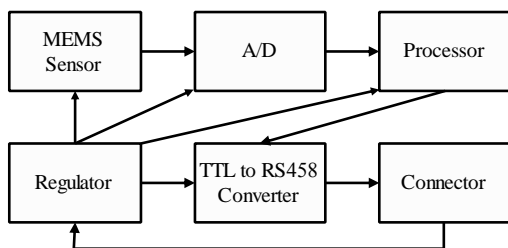

Fig. 1. Internal block diagram of an accelerometer

3. The System Modeling

Analysis of dynamic processes of real objects can be expensive, time-consuming and, in certain cases, impossible, whereas experiments can be easily carried out on models which can be used to simulate dynamic responses. For this purpose, physical and mathematical models of an object should be built and followed by estimation of model parameters and verification. This section describes the model of the suspension system and road roughness.



Fig. 2. The produced accelerometer

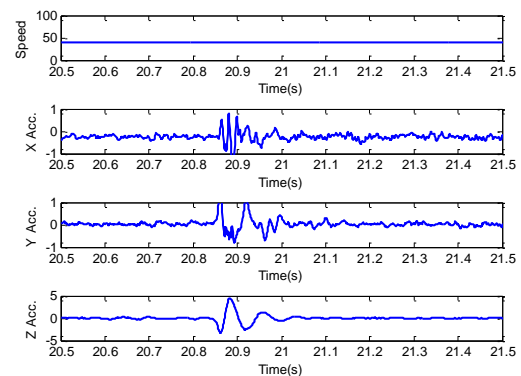

Fig. 3. The suspension system accelerations on a bump with a -10 Cm length and a-5 Cm depth

I. Suspension System Modeling

In order to address these issues and be able to apply proposed method, a suspension system model is created. The suspension system model is shown in Fig. 4 and equations (1) and (2) show the dynamic of the system [5].

$$m_s \cdot \ddot{x}_c = k_s(x_w - x_c) + c_s(\dot{x}_w - \dot{x}_c) \tag{1}$$

$$m_{us} \cdot \ddot{x}_w = k_{us}(x_r - x_w) + c_{us}(\dot{x}_r - \dot{x}_w) - k_s(x_w - x_c) - c_s(\dot{x}_w - \dot{x}_c) \tag{2}$$

where m_s , m_{us} , k_s , k_{us} , c_s and c_{us} denote the mass, stiffness and damping rate of the sprung and

un-sprung elements, respectively. The variables x_c , x_w and x_r are the displacements of the sprung mass, un-sprung mass and road, respectively. These equations can be written in a state-space form

$$\dot{X} = A_1 X + B_1 u \tag{3}$$

where $X = [x_r - x_w, \dot{x}_w, x_w - x_c, \dot{x}_c]^T$ and $u = [\dot{x}_r]$. \dot{x}_r is the disturbance to the system.

The parameters of the suspension system model are shown in Table 1.

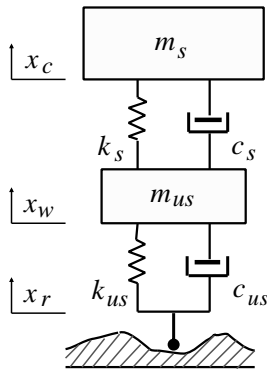

Fig. 4. The suspension system model

Table 1. The parameters of suspension system model

m_s	m_{us}	C_s	C_{us}	K_s	K_{us}
243	40	370	414	14671	124660
Kg	Kg	N/m/Sec	N/m/Sec	N/m	N/m

II. Road Modeling

Many researchers have modeled road roughness [4,8,14,20]. In [20] equation (4) was used to describe the road roughness.

$$\dot{x}_r(t) + 2\pi V n_0 x_r(t) = \sqrt{G_q(\Omega_0)} V w(t) \tag{4}$$

where x_r , V , n_0 , $G_q(\Omega_0)$, Ω_0 and w are displacement, speed, reference spatial frequency, road power spectral density, reference spatial angular frequency and noise, respectively. The equation (5) is used if the speed of the vehicle is time variable.

$$\dot{x}_r(t) + 2\pi V(t) n_0 x_r(t) = \sqrt{G_q(\Omega_0)} V(t) w(t) \tag{5}$$

In order to learn neural networks, model and inverse model, the block diagram of equation (4), as shown in Fig. 5, is used to generate road roughness.

In [14] the bump is simulated as sin function, that shown in equation (6) and Fig. 6. It is assumed that the vehicle experiences a sudden bump with amplitude of 11cm, the profile of which is shown in Fig. 6 and described by equation (6).

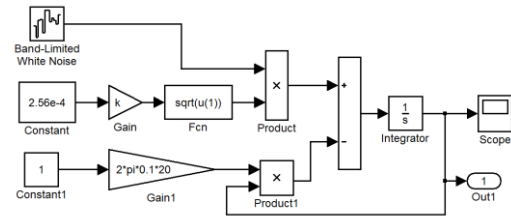

Fig. 5. The block diagram model of the road roughness

$$\omega(t) = \begin{cases} \frac{a}{2} \left(1 - \cos \left(\frac{2\pi V t}{\lambda} \right) \right) & \text{if } 1.25 \leq t \leq 1.5 \\ 0 & \text{otherwise} \end{cases} \tag{6}$$

where a , V and λ are amplitude of roughness, speed of the vehicle and half of the sin wavelength, respectively. In this paper, equation (6) is used to test neural networks model and neural networks inverse model.

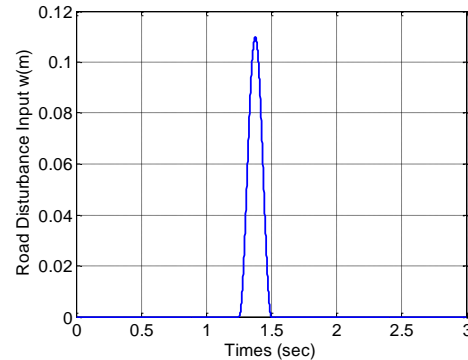

Fig. 6. Road displacement model

4. System Identification with Neural Networks

The neural networks in this research are used to identify a nonlinear model of suspension system and inverse suspension system model. One of the well-known nonlinear model structures is Non-linear Auto-Regressive with eXogenous (NARX). It has been widely used for modeling the nonlinear system dynamics. There are two methods for identifying a system with neural networks [16]. In first method, shown in equation (7), the output of the real system is used for learning neural networks model and in the second method, shown in equation (8), the output of the neural networks model is used for learning the networks. This issue uses second method to identify the suspension system model as shown in Fig. 7. In order to identify nonlinear model, input output data are acquired by driving a car on a given road roughness.

$$\hat{y}(t) = f[u(t), \dots, u(t-m), y(t-1), \dots, y(t-n)] \quad (7)$$

$$\hat{y}(t) = f[u(t), \dots, u(t-m), \hat{y}(t-1), \dots, \hat{y}(t-n)] \quad (8)$$

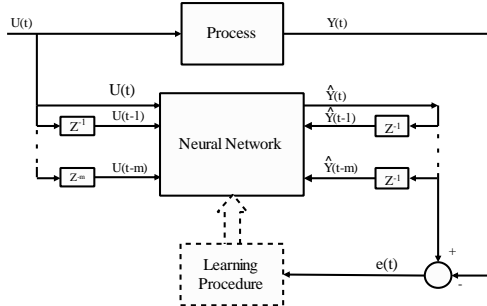

Fig. 7. Modeling a real system by neural networks

I. The Suspension System Modeling with Neural Networks

In order to sampling the equations (1) and (2) there are

$$\begin{aligned} T \dot{x}_w &= x_w(k+1) - x_w(k) \\ T \dot{x}_c &= x_c(k+1) - x_c(k) \\ T \dot{x}_r &= x_r(k+1) - x_r(k) \end{aligned} \quad (9)$$

$$\begin{aligned} T^2 \ddot{x}_w &= x_w(k+1) - 2x_w(k) + x_w(k-1) \\ T^2 \ddot{x}_c &= x_c(k+1) - 2x_c(k) + x_c(k-1) \end{aligned}$$

where T is the sampling period. Therefore, replacing these relations into equations (1) and (2) and using the n-order approximation method, the model can be denoted in the discrete form as

$$x_c(k) = Ax_c(k-1) + Bx_c(k-2) + Cx_w(k) + Dx_w(k-1) \quad (10)$$

$$x_w(k) = Ex_w(k-1) + Fx_w(k-2) + Gx_c(k) + Hx_c(k-1) + Kx_r(k) + Lx_r(k-1) \quad (11)$$

where A-L are constant that depend on sampling period, mass, stiffness and damping rate of the sprung and un-sprung elements, also $x_c(k)$ and $x_w(k)$ are the sprung mass and un-sprung mass displacement, respectively. For example in equation (10) $B = -m_s / (m_s + c_s T)$. These equations can be show as:

$$x_c(k) = f[x_c(k-1), x_c(k-2), x_w(k), x_w(k-1)] \quad (12)$$

$$x_w(k) = g \begin{bmatrix} x_w(k-1), x_w(k-2), x_c(k), \\ x_c(k-1), x_r(k), x_r(k-1) \end{bmatrix} \quad (13)$$

A feed-forward, multi-layer perceptron (MLP) whit 6 inputs, one hidden layer and one output is used to identify the system. The output of neural networks can be shown as:

$$y_k = \sum_{i=1}^{N_h} \delta \left(\sum_{j=1}^{N_i} W_{ij} X_j + b_i \right) \cdot W_{ki} + b_k \quad (14)$$

where $N_i, N_h, W_{ij}, W_{ik}, X_j, b_j$ and b_k are number

of inputs, number of neurons in hidden layer, weights between input and hidden layer, weights between output and hidden layer, inputs, bias of hidden neurons and bias of output neuron, respectively. The sigmoid activation function ($\delta(\cdot)$) has been used in the hidden layer and linear activation function in the output layer.

Back propagation neural networks most commonly used to update weights of neural networks. Therefore, the error back propagation was used for the system identification. Training inputs are supplied to the input layer of the network in a forward sweep such that the output of each element is computed layer by layer. The output of the final layer is compared with the desired output such that the error is back-propagated through the previous layers. The objective of the identification process is to minimize the error signals $e_c(k) = x_c(k) - \hat{x}_c(k)$, $e_w(k) = x_w(k) - \hat{x}_w(k)$ when the plant and neural networks model are subjected to the same input x_r (see Fig. 8), where $\hat{x}_c(k)$, $\hat{x}_w(k)$ are the neural networks model output, $x_c(k)$, $x_w(k)$ are the plant output. Weights between input layer and hidden layer are updated as:

$$\Delta W_{ij}(t) = -\eta \frac{\partial E_2(t)}{\partial W_{ij}(t)} + \alpha \Delta W_{ij}(t-1) \quad (15)$$

where η is learning rate and α is momentum term and $E_2(t)$ is propagation error between the hidden layer and the input layer. Weights between hidden layer and output layer are updated as

$$\Delta W_{ki}(t) = -\eta \frac{\partial E_1(t)}{\partial W_{ki}(t)} + \alpha \Delta W_{ki}(t-1) \quad (16)$$

$E_1(t)$ is error between output layer and hidden layer. Equation (4) is used to prepare road roughness on the wheels of the vehicle. The system input is road roughness and the outputs of the real system are displacement on the sprung mass and un-sprung mass. The inputs to neural networks are random road roughness, delayed of random road roughness, outputs and delayed of outputs. Therefore, the neural networks model uses plant input, previous plant inputs, and previous neural networks model outputs to predict values of the plant output. This step is shown in Fig. 8. To account for interaction with other parts of vehicle and to close the simulation to real world, the white noise is added to inputs of neural networks during learning.

In learning process, the speed is assumed to be 20 m/s. The inputs of neural networks model are 6 and the outputs are 2. Only one hidden layer with 4 neurons was sufficient to obtain satisfactory results. The sigmoid activation function has been used in the hidden layer and linear activation function in the output layer.

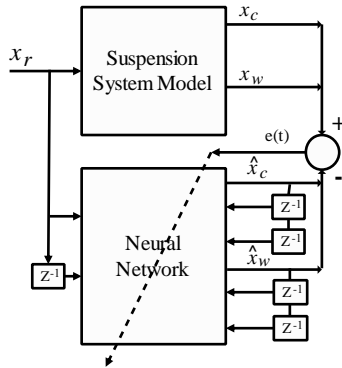

Fig. 8. The suspension system modeled by neural networks

The vehicle moves over different road roughness and produces accelerations and displacements. The neural networks learn the system from these inputs and previous inputs and outputs. The estimation and validation data sets are presented in Fig. 9 to Fig. 12. These figures show the comparison between outputs of the real model and neural networks model. The mean error in Fig. 12 is 0.0013% and max error is 0.0012.

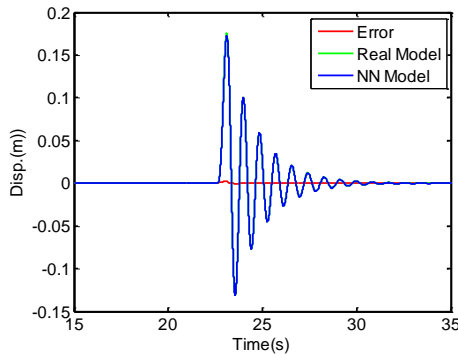

Fig. 9. Displacement of the sprung mass for passing over the bump

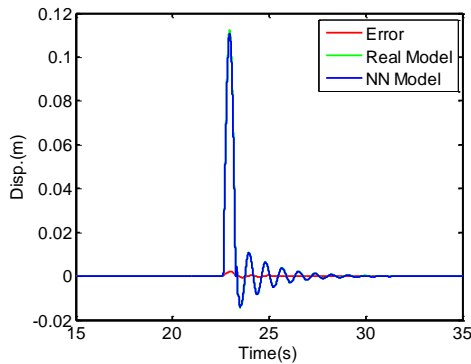

Fig. 10. Displacement of un-sprung mass for passing over the bump

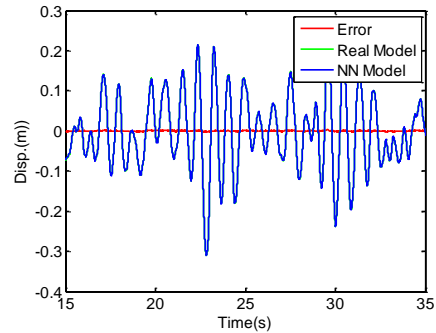

Fig. 11. Displacement of the sprung mass for passing over random roughness

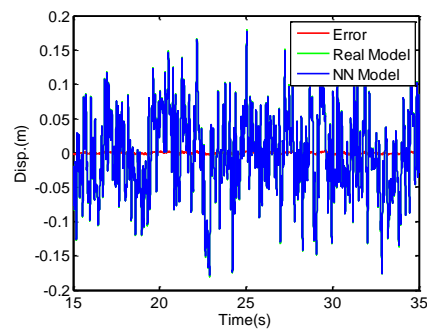

Fig. 12. Displacement of un-sprung mass for passing over random roughness

II. Inverse Modeling Suspension System with Neural Networks

The suspension system was identified in previous section. In this section, a method is proposed to identify the inverse model of the suspension system. Therefore, the overall method can be shown as Fig. 13.

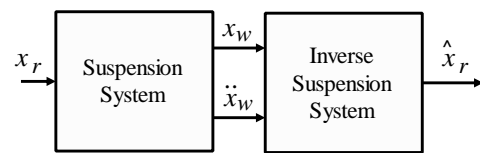

Fig. 13. Proposed method to predict road roughness

In Fig. 13, x_r, x_w, \ddot{x}_w and \hat{x}_r are the road roughness, displacement, acceleration and predicted road roughness, respectively. The neural networks based on the inverse modeling are implemented to predict the road roughness. The vibration data used for training and testing the inverse model is generated when the vehicle travelling on the road. Based on previous sections, the accelerations of the sprung and un-sprung mass are measurable. The displacement can be calculated as

$$d = \iint_0 \alpha(t) dt + \alpha(0) \quad (17)$$

where α is acceleration and $\alpha(0)=0$.

Therefore, the inputs of neural networks are accelerations and displacement and the output is road roughness. In other words, inputs for neural networks as inverse model are outputs of suspension system model. As shown in Fig. 14, the neural networks learn the inverse suspension system to predict road roughness. If the errors close to zero, then the inverse suspension system model is identified by neural networks.

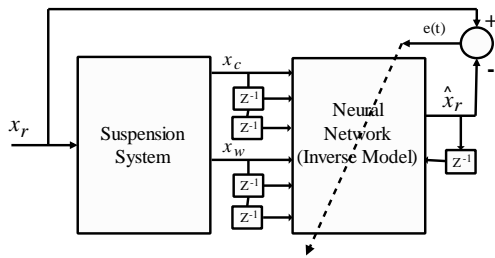

Fig. 14. Inverse modeling suspension system by neural networks

The input-hidden and hidden-output weights of neural networks, that identify the inverse suspension system, are shown in Table 2 and Table 3. In these tables X and b are inputs and bias, respectively.

Table 2. the input-hidden weights of neural Networks (Nr=Neuron)

	Nr.1	Nr. 2	Nr. 3	Nr. 4
X1	2.35	1.59	0.75	2.80
X2	1.72	-4.56	3.63	-0.01
X3	3.52	2.28	-1.52	2.98
X4	3.56	-0.30	0.77	-2.43
X5	-1.38	6.06	-7.17	4.96
X6	1.95	-4.65	3.55	4.11
X7	1.91	2.38	0.10	-1.37
b	-1.15	-0.08	0	1.98

Table 3. the hidden-output weights of neural Networks

Hidden Neuron	Output Neuron
1	0.00029744
2	-0.0011246
3	8.7651
4	0.00077146
b	-0.0237

The results of this step are shown in Fig. 15 and Fig. 16. The mean error that is shown in these figures are 2.1% and max error is 0.028. Therefore these figures show that the proposed method in this paper

presents a perfect solution to predict the quality of roads.

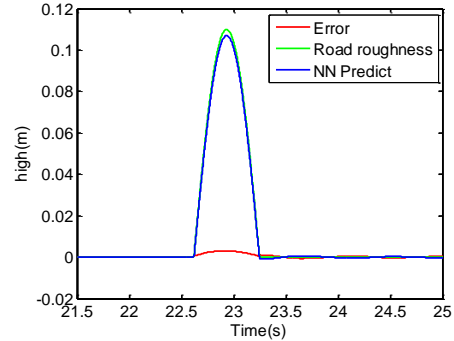

Fig. 15. Bump roughness prediction by neural networks

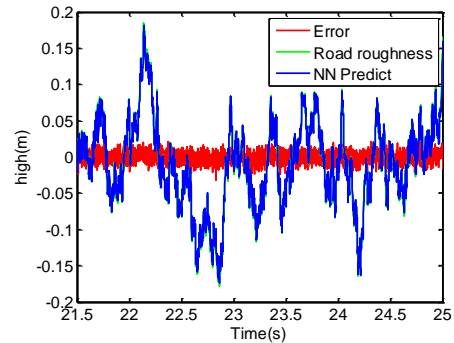

Fig. 16. Random roughness prediction by neural networks

5. Conclusion

When a vehicle travels along a road, different parts of vehicle will be vibrating. Vehicle vibration is mainly due to road roughness. The main contribution of this paper is to predict road roughness based on vertical acceleration in vehicles by using neural networks. To this end, first, the suspension system model and road roughness were introduced. Then, the suspension system model was identified using neural networks. The results of this step are shown in Fig. 9 to Fig. 12. These figures and mean error (0.0013%) show that the neural networks model of suspension system will be well. In third step, using neural networks, the inverse suspension system model is identified in order to determine the relationship between road roughness and vibration or displacement. The mean error is 2.1%, also results of this step are shown in Fig. 15 and Fig. 16. Therefore, the proposed method in this paper presents a perfect solution to predict the quality of roads. Unfortunately, due to paucity of previous research on this issue, numerical comparison is not possible.

Acknowledgment

This work was supported by a Grant from Shahrood University of Technology.

References

- [1] Cundill MA (1991) The MERLIN low-cost road roughness measuring machine. Digest of Research Report 301.
- [2] Eski I, Yildirim S (2009) Vibration control of vehicle active suspension system using a new robust neural network control system. *Simulation Modeling Practice and Theory* 17: 778–793.
- [3] Hanafi, Rahmat MF (2008) Neural network based system identification of an axis of car suspension system. *J Teknik Elektro* 8(1): 1–7.
- [4] Marzbanrad J, Ahmadi G, Zohoor H, Hojjat Y (2004) Stochastic optimal preview control of a vehicle suspension, *J Sound and Vibration* 275: 973–990.
- [5] Chantranuwathana S, Peng H (2000) Practical adaptive controllers for active suspensions. Proc ASME International Congress and Exposition (IMECE), Orlando, Florida.
- [6] Kar C, Mohanty AR (2008) Vibration and current transient monitoring for gearbox fault detection using multiresolution fourier transform. *J Sound and Vibration* 311: 109–132.
- [7] Yang B, Lim DS, Chiow Tan AC (2005) VIBEX: an expert system for vibration fault diagnosis of rotating machinery using decision tree and decision table. *J Expert Systems with Applications* 28: 735–742.
- [8] Uys PE, Els PS, Thoreson M (2007) Suspension settings for optimal ride comfort of off-road vehicles travelling on roads with different roughness and speeds. *J Terramechanics* 44: 163–175.
- [9] Jönsson P, Johansson Ö (2005) prediction of vehicle discomfort from transient vibrations. *J Sound and Vibration* 282: 1043–1064.
- [10] Morosiuk G, Jones CR, Osman M (1992) Calibration and standardization of road roughness measurements using the TRL profile beam. Proc the Seventh REAAA Conference, Singapore.
- [11] Ramji K, Gupta A, Saran VH, Goel VK, Kumar V (2004) Road roughness measurements using PSD approach. *IE (I) J CV* 85.
- [12] Sayers MW, Gillespie TD, Paterson WD (1982) Guidelines for conducting and calibrating road roughness measurements. World Bank Technical Paper Number 46.
- [13] Guclu R, Gulez K (2008) Neural network control of seat vibrations of a non-linear full vehicle model using PMSM. *Mathematical and Computer Modeling* 47: 1356–1371.
- [14] Olurotimi A, Dahunsi, Pedro JO (2010) Neural network-based identification and approximate predictive control of a servo-hydraulic vehicle suspension system. *Engineering Letters*.
- [15] Yildirim S, Eski I (2009) vibration analysis and experimental suspension system using artificial neural networks. *J Scientific & Industrial Research* 68: 522–529.
- [16] Alippi C, Piuri V (1996) experimental neural networks for prediction and identification. *J Instrumentation and Measurement* 45(2):670–676.
- [17] Xiaofang Y, Yaonan W, Wei S, Lianghong W (2010) RBF networks-based adaptive inverse model control system for electronic throttle. *J Control Systems Technology* 18(3):750–756.
- [18] Qian W, Jiaxue L (2010) A Neural Network Adaptive Inverse Controller for Hypersonic Vehicle, ICINA.
- [19] Shiguemori EH, Chiwiacowsky LD, de Campos Velho HF (2005) An inverse vibration problem solved by an artificial neural network. *TEMA Tend Mat Apl Comput* 6(1): 163–175.
- [20] He L, Qin G, Zhang Y, Chen L (2008) Non-stationary random vibration analysis of vehicle with fractional damping. *International Conference on Intelligent Computation Technology and Automation*.